

# HANDHELD SCANNER

• Product availability and specifications depend on territory market strategy; all are subjects to change without prior notice.  
 • ZEBEX is the trademark of ZEBEX INDUSTRIES INC, all rights reserved.

## Z-3102

### 2D Image Handheld Scanner

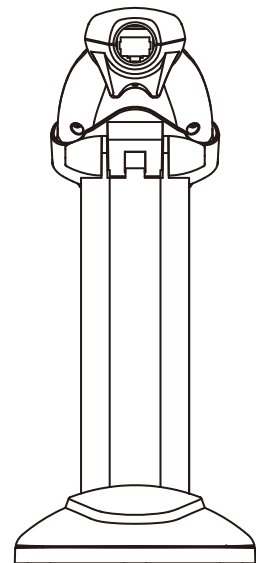
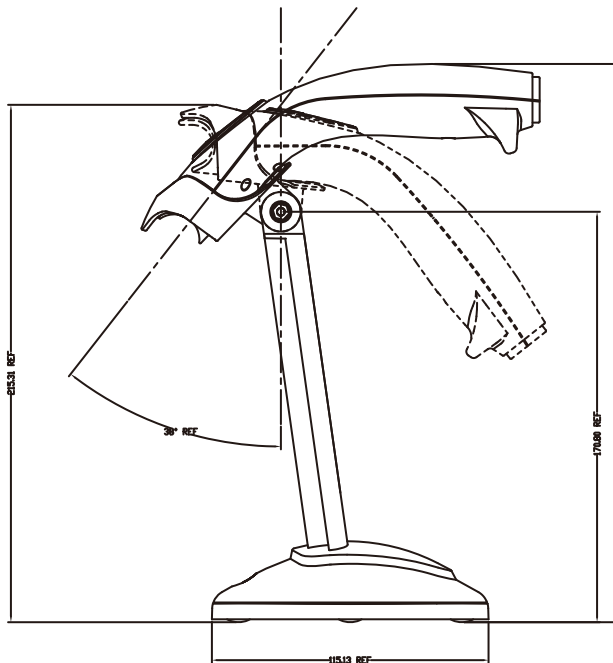
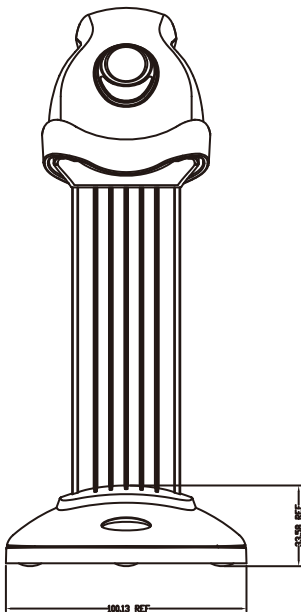
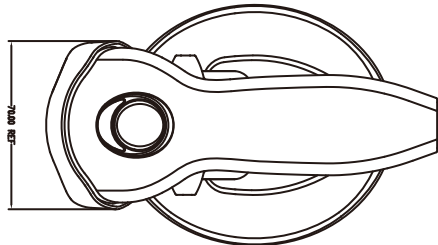
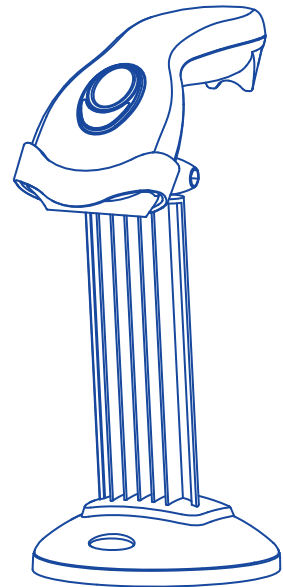
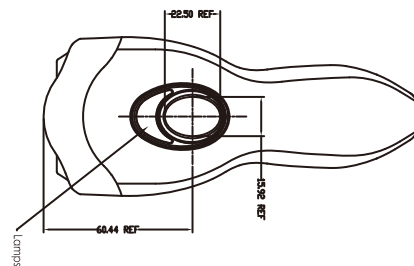
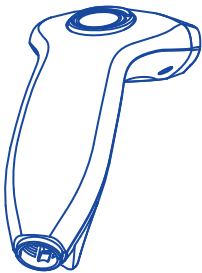
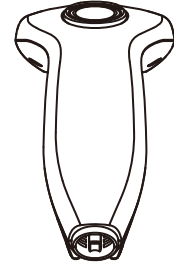
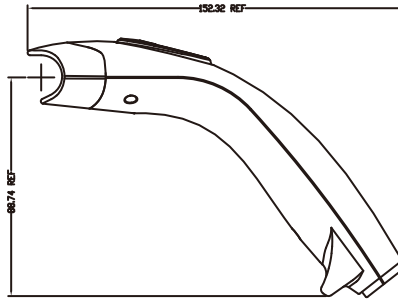
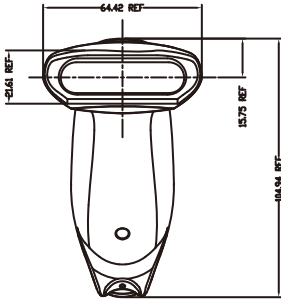

Units: mm(inch)  
 Ver. 2024/06/17